

TOSHIBA



50UA2063DB

QUICK START GUIDE

Please visit www.toshiba-tv.com to download the full user manual.

1 Building and fitting stand

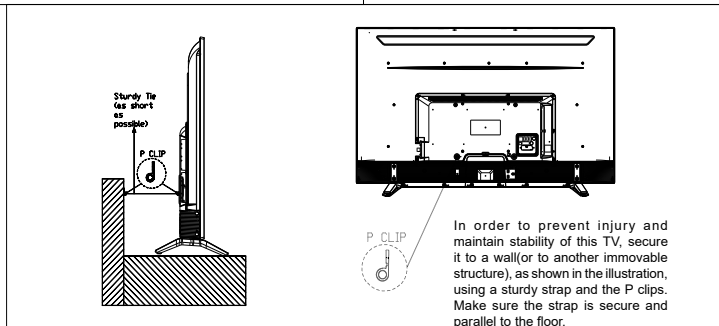
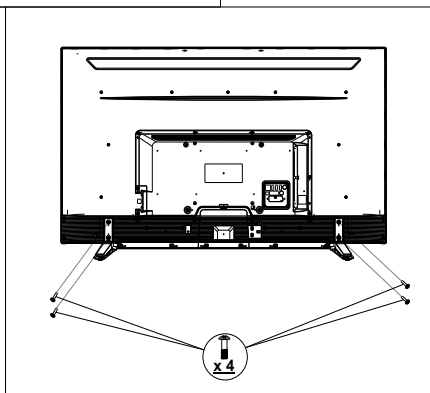
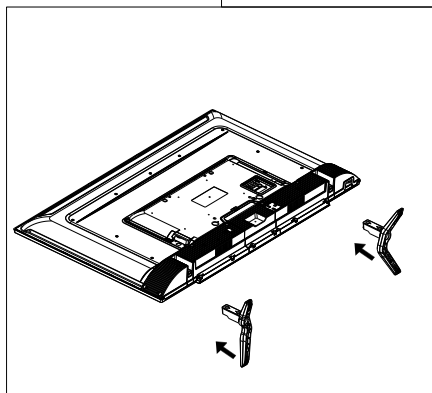
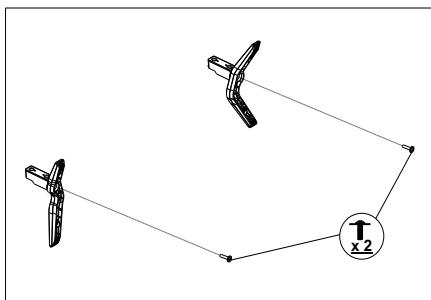

2 Inserting the batteries into the remote

Remove the screw that secures the battery compartment cover on the back side of the remote control first. Lift the cover gently. Insert two 1.5V - size **AAA** batteries. Make sure the (+) and (-) signs match (observe correct polarity). Do not mix old and new batteries. Replace only with same or equivalent type. Place the cover back on. Then screw the cover back on again.

3 Connections

Antenna

Connect the antenna cable/s to your TV.

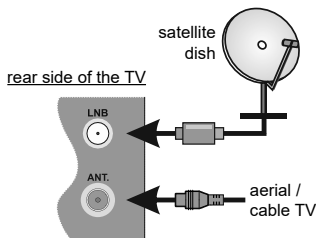

Power

After unpacking, allow the TV set to reach the ambient room temperature before you connect the set to the mains. Plug the power cable to the mains socket outlet.

Plug the power cable to the mains socket whilst in 'off' position, and then turn the mains socket on.

IMPORTANT: The TV set is designed to operate on a **220-240V AC, 50 Hz** supply.

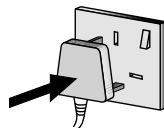

External Devices



PLEASE ENSURE BOTH UNITS ARE SWITCHED OFF BEFORE CONNECTING

Use the proper cable to connect two units together.

To select the desired input source, press the **Source** button on the remote control.

HDMI connection

rear side or rear-left side of TV



4 Switching on the TV

In order to turn the TV on from standby mode:

- Press the **Standby** button on the remote control
- Press the control button on the TV

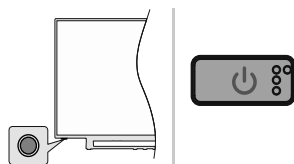

5 Internet connection

You can set up your TV so that it can access the Internet through your local area network (LAN) using a wired or wireless connection. Refer to full user manual for detailed instructions.

Wired

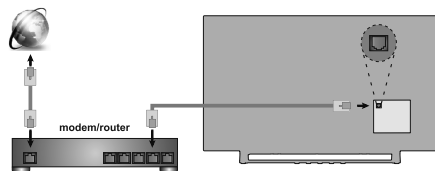

Note: The figures are for representation only

Wireless

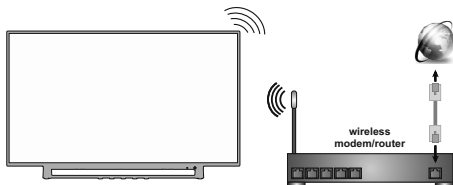

6 Remote control

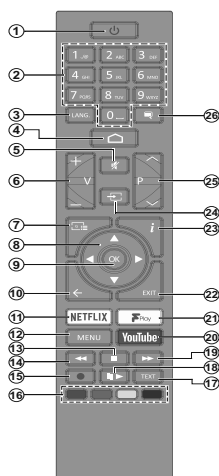

1. Standby
2. Numeric buttons
3. Language
4. Home
5. Mute
6. Volume +/-
7. Guide
8. Directional buttons
9. OK
10. Back/Return
11. Netflix
12. Menu
13. Stop
14. Rewind
15. Record
16. Coloured Buttons
17. Text
18. Pause
19. Play
20. YouTube
21. Freeview Play
22. Exit
23. Info
24. Source
25. Programme +/-
26. Subtitles

7 Initial setup wizard

When turned on for the first time, a search for accessories will be performed before the initial setup starts. Follow the on-screen instructions to pair your remote control and other wireless accessories with your TV. To pair your remote press and hold the **Source** button for about 5 seconds. Press **BACK** to end adding accessories and start the setup. After that welcome screen will be displayed. Select your language and press **OK**. Follow the on-screen instructions to set your TV and install channels. The installation wizard will guide you through the setup process. You can perform initial setup anytime using the **Reset** option in the **Settings>Device Preferences** menu. You can access the **Settings** menu from the Home Screen or from the **TV options** menu in Live TV mode.

8 Accessing the full user manual

You can review your TV's full user manual online or download as you like. Scan this QR code or visit <https://toshiba-tv.com>



Accessories Included

- Remote Control
- Batteries: 2 x AAA
- Quick Start Guide
- P-clip x2
- Stand x2
- Screw x6

Feature Overview

Multi Media Player

Browse the media content stored on USB devices that are connected to your TV or on mobile devices that are connected to the same network as your TV using the MMP app

Common Interface

Decode encrypted digital TV channels with a Conditional Access Module(CAM) and a card provided by a digital TV service operator

USB Recording

Record your favourite TV programmes

Electronic Programme Guide

Display the scheduled digital TV programmes

CEC

Control basic functions of the connected HDMI-CEC compatible audio/video devices with the remote control of the TV

HbbTV

Access to HbbTV services (services are dependant on broadcast)

Apps

Access the applications installed on your TV, add more from the market

Google Cast

With the built-in Google Cast technology you can cast the content from your mobile device straight to your TV.

Voice Search

You can start a voice search using your remote's built-in microphone

Bluetooth®

Connect audio devices or remote controller wirelessly to your TV.

Some features may not be available, dependant on your TV model. Please check the product fiche for the product specifications relating to your model.

For more detailed information and videos on installation, function and features of your TV, refer to the full manual on our website:
<https://toshiba-tv.com/uk-uk/support>



High Dynamic Range (HDR) / Hybrid Log-Gamma (HLG)

Using this feature the TV can reproduce greater dynamic range of luminosity by capturing and then combining several different exposures. HDR/HLG promises better picture quality thanks to brighter, more realistic highlights, more realistic colour and other improvements. It delivers the look that filmmakers intended to achieve, showing the hidden areas of dark shadows and sunlight with full clarity, colour and detail. HDR/HLG contents are supported via native and market applications, HDMI, USB inputs and over DVB-S broadcasts. When the input source is set to the related HDMI input press the **Menu** button and set the **HDMI EDID Version** option in the **TV Options>Settings>Device Preferences>Inputs** menu as **EDID 2.0** or **Auto EDID** in order to watch HDR/HLG content, if the HDR/HLG content is received through an HDMI input. The source device should also be at least HDMI 2.0a compatible in this case.

Dolby Vision

Dolby Vision™ delivers a dramatic visual experience, astonishing brightness, exceptional contrast, and vivid colour, that brings entertainment to life. It achieves this stunning image quality by combining HDR and wide colour gamut imaging technologies. By increasing the brightness of the original signal and using a higher dynamic colour and contrast range, Dolby Vision presents amazing true-to-life images with stunning detail that other post-processing technologies in the TV aren't able to produce. Dolby Vision is supported via native and market applications, HDMI and USB inputs. When the input source is set to the related HDMI input press the **Menu** button and set the **HDMI EDID Version** option in the **TV Options>Settings>Device Preferences>Inputs** menu as **EDID 2.0** or **Auto EDID** in order to watch HDR/HLG content, if the HDR/HLG content is received through an HDMI input. The source device should also be at least HDMI 2.0a compatible in this case. In the **Picture Mode** menu two predefined picture modes will be available if Dolby Vision content is detected: **Dolby Vision Bright** and **Dolby Vision Dark**. Both allow the user to experience the content in the way the creator originally intended with different ambient lighting conditions. To change the **Picture Mode** setting press the **Menu** button while watching the Dolby Vision content and go to **Picture** menu. While watching Dolby Vision Content via an application, except YouTube, Netflix and Multi Media Player, you will not be able to access the Picture menu and set the Picture Mode.

Safety Information

	CAUTION RISK OF ELECTRIC SHOCK DO NOT OPEN	
CAUTION: TO REDUCE THE RISK OF ELECTRIC SHOCK DO NOT REMOVE COVER (OR BACK). NO USER-SERVICEABLE PARTS INSIDE. REFER SERVICING TO QUALIFIED SERVICE PERSONNEL.		

In extreme weather (storms, lightning) and long inactivity periods (going on holiday) disconnect the TV set from the mains.

The mains plug is used to disconnect TV set from the mains and therefore it must remain readily operable. If the TV set is not disconnected electrically from the mains, the device will still draw power for all situations even if the TV is in standby mode or switched off.

Note: Follow the on screen instructions for operating the related features.

IMPORTANT - Please read these instructions fully before installing or operating

WARNING: This device is intended to be used by persons (including children) who are capable / experienced of operating such a device unsupervised, unless they have been given supervision or instruction concerning the use of the device by a person responsible for their safety.

- Use this TV set at an altitude of less than 5000 metres above the sea level, in dry locations and in regions with moderate or tropical climates.
- The TV set is intended for household and similar indoor use but may also be used in public places.
- For ventilation purposes, leave at least 5cm of free space around the TV.
- The ventilation should not be impeded by covering or blocking the ventilation openings with items, such as newspapers, table-cloths, curtains, etc.
- The power cord/plug should be easily accessible. Do not place the TV, furniture, etc. on the power cord. A damaged power cord/plug can cause fire or give you an electric shock. Handle the power cord by the plug, do not unplug the TV by pulling the power cord. Never touch the power cord/plug with wet hands as this could cause a short circuit or electric shock. Never make a knot in the power cord or tie it with other cords. When damaged it must be replaced, this should only be done by qualified personnel.
- Do not expose the TV to dripping or splashing of liquids and do not place objects filled with liquids, such as vases, cups, etc. on or over the TV (e.g. on shelves above the unit).
- Do not expose the TV to direct sunlight or do not place open flames such as lit candles on the top of or near the TV.





- Do not place any heat sources such as electric heaters, radiators, etc. near the TV set.
- Do not place the TV on the floor and inclined surfaces.
- To avoid danger of suffocation, keep plastic bags out of the reach of babies, children and domestic animals.
- Carefully attach the stand to the TV. If the stand is provided with screws, tighten the screws firmly to prevent the TV from tilting. Do not over-tighten the screws and mount the stand rubbers properly.
- Do not dispose of the batteries in fire or with hazardous or flammable materials.

WARNING

- Batteries must not be exposed to excessive heat such as sunshine, fire or the like.
- Excessive sound pressure from earphones or headphones can cause hearing loss.

ABOVE ALL - NEVER let anyone, especially children, push or hit the screen, push anything into holes, slots or any other openings in the case.

 Caution	Serious injury or death risk
 Risk of electric shock	Dangerous voltage risk
 Maintenance	Important maintenance component

Markings on the Product

The following symbols are used on the product as a marker for restrictions and precautions and safety instructions. Each explanation shall be considered where the product bears related marking only. Note such information for security reasons.



Class II Equipment: This appliance is designed in such a way that it does not require a safety connection to electrical earth.



Hazardous Live Terminal: The marked terminal(s) is/are hazardous live under normal operating conditions.



Caution, See Operating Instructions: The marked area(s) contain(s) user replaceable coin or button cell batteries.



Class 1 Laser Product: This product contains Class 1 laser source that is safe under reasonably foreseeable conditions of operation.

WARNING

Do not ingest the battery, Chemical Burn Hazard. This product or the accessories supplied with the product may contain a coin/button cell battery. If the coin/button cell battery is swallowed, it can cause severe internal burns in just 2 hours and can lead to death.

Keep new and used batteries away from children. If the battery compartment does not close securely, stop using the product and keep it away from children.

If you think batteries might have been swallowed or placed inside any part of the body, seek immediate medical attention.

Never place a television set in unstable or inclined locations. A television set may fall, causing serious personal injury or death. Many injuries, particularly to children, can be avoided by taking simple precautions such as;

- Using cabinets or stands recommended by the manufacturer of the television set.
- Only using furniture that can safely support the television set.
- Ensuring the television set is not overhanging the edge of the supporting furniture.
- Not placing the television set on tall furniture (for example, cupboards or bookcases) without anchoring both the furniture and the television set to a suitable support.
- Not standing the television set on cloth or other materials placed between the television and supporting furniture.
- Educating children about the dangers of climbing on furniture to reach the television set or its controls. If your existing television set is being retained and relocated, the same considerations as above should be applied.

Apparatus connected to the protective earthing of the building installation through the MAINS connection or through other apparatus with a connection to protective earthing – and to a television distribution system using coaxial cable, may in some circumstances create a fire hazard. Connection to a television distribution system has therefore to be provided through a device providing electrical isolation below a certain frequency range (galvanic isolator).

Using the special functions to change the size of the displayed image (i.e. changing the height/width ratio) for the purposes of public display or commercial gain may infringe on copyright laws.

The LCD display panels are manufactured using an extremely high level of precision technology; however, sometimes some parts of the screen may be missing picture elements or have luminous spots. This is not a sign of a malfunction.

The set should be operated only from a 220-240 V AC 50 Hz outlet. Ensure that the television is not standing on the mains lead. Do not cut off the mains plug from this equipment, this incorporates a special Radio Interference Filter, the removal of which will impair its performance. It should only be replaced by a correctly rated and approved type. IF IN DOUBT PLEASE CONSULT A COMPETENT ELECTRICIAN.

WALL MOUNTING WARNINGS

- Read the instructions before mounting your TV on the wall.
- The wall mount kit is optional. You can obtain from your local dealer, if not supplied with your TV.
- Do not install the TV on a ceiling or on an inclined wall.
- Use the specified wall mounting screws and other accessories.
- Tighten the wall mounting screws firmly to prevent the TV from fall. Do not over-tighten the screws.

Figures and illustrations in this user manual are provided for reference only and may differ from the actual product appearance. Product design and specifications may be changed without notice.

Licences

The terms HDMI and HDMI High-Definition Multimedia Interface, and the HDMI Logo are trademarks or registered trademarks of HDMI Licensing Administrator, Inc. in the United States and other countries.



Dolby, Dolby Vision, Dolby Audio, and the double-D symbol are trademarks of Dolby Laboratories Licensing Corporation. Manufactured under license from Dolby Laboratories. Confidential unpublished works. Copyright © 1992-2021 Dolby Laboratories. All rights reserved.

Google, Android, Android TV, Chromecast, Google Play and YouTube are trademarks of Google LLC.

For DTS patents, see <http://patents.dts.com>. Manufactured under licence from DTS Licensing Limited. DTS, the Symbol, DTS and the Symbol together, DTS-HD, and the DTS-HD logo are registered trademarks or trademarks of DTS, Inc. in the United States and/or other countries. © DTS, Inc. All Rights Reserved.



The **Bluetooth®** word mark and logos are registered trademarks owned by the Bluetooth SIG, Inc. and any use of such marks by Vestel Elektronik Sanayi ve Ticaret A.S. is under licence. Other trademarks and trade names are those of their respective owners.

DVB is a registered trademark of the DVB Project.

[1] EIA/CEA-861-D compliance covers the transmission of uncompressed digital video with high-bandwidth digital content protection, which is being standardised for reception of high-definition video signals. Because this is an evolving technology, it is possible that some devices may not operate properly with the television.

This product contains technology subject to certain intellectual property rights of Microsoft. Use or distribution of this technology outside of this product is prohibited without the appropriate licence(s) from Microsoft.

Content owners use Microsoft PlayReady™ content access technology to protect their intellectual property, including copyrighted content. This device uses PlayReady technology to access PlayReady-protected content and/or WMDRM-protected content. If the device fails to properly enforce restrictions on content usage, content owners may require Microsoft to revoke the device's ability to consume PlayReady-protected content. Revocation should not affect unprotected content or content protected by other content access technologies. Content owners may require you to upgrade PlayReady to access their content. If you decline an upgrade, you will not be able to access content that requires the upgrade.

The "CI Plus" Logo is a trademark of CI Plus LLP.

This product is protected by certain intellectual property rights of Microsoft Corporation. Use or distribution of such technology outside of this product is prohibited without a licence from Microsoft or an authorised Microsoft subsidiary.

Wireless LAN Transmitter Specifications

Frequency Ranges	Max Output Power
2400 - 2483,5 MHz (CH1 - CH13)	< 100 mW
5150 - 5250 MHz (CH36 - CH48)	< 200 mW
5250 - 5350 MHz (CH52 - CH64)	< 200 mW
5470 - 5725 MHz (CH100 - CH140)	< 200 mW

Country Restrictions

This device is intended for home and office use in all EU countries (and other countries following the relevant EU directive) without any limitation except for the countries mentioned below.

Country	Restriction
Bulgaria	General authorisation required for outdoor use and public service
Italy	If used outside of own premises, general authorisation is required
Greece	In-door use only for 5470 MHz to 5725 MHz band
Luxembourg	General authorisation required for network and service supply(not for spectrum)
Norway	Radio transmission is prohibited for the geographical area within a radius of 20 km from the centre of Ny-Ålesund
Russian Federation	In-door use only
Israel	5 GHz band only for 5180 MHz - 5320 MHz range

The requirements for any country may change at any time. It's recommended that user checks with local authorities for the current status of their national regulations for 5 GHz wireless LAN's.

Specification

TV Broadcasting	PAL BG//DK SECAM BG/DK
Receiving Channels	VHF (BAND I/III) - UHF (BAND U) - HYPERBAND
Digital Reception	Fully integrated digital terrestrial-cable-satellite TV(DVB-T-C-S) (DVB-T2, DVB-S2 compliant)
Number of Preset Channels	12200
Channel Indicator	On Screen Display
RF Aerial Input	75 Ohm (unbalanced)
Operating Voltage	220-240V AC, 50Hz.
Audio	DTS HD
Audio Output Power (WRMS.) (10% THD)	2 x 10
Power Consumption (W)	135 W
Networked Standby Power Consumption (W)	< 2
Weight (Kg)	10.5
TV Dimensions DxLxH (with foot) (mm)	245 x 1129 x 710
TV Dimensions DxLxH (without foot) (mm)	81 x 1129 x 655
Display	16:9 50"
Operation temperature and operation humidity	0°C up to 40°C, 85% humidity max

Disposal...

The following information is only for EU-member states:

Disposal of products

The crossed out wheeled dust bin symbol indicates that products must be collected and disposed of separately from household waste. Integrated batteries and accumulators can be disposed of with the product. They will be separated at the recycling centres.



The black bar indicates that the product was placed on the market after August 13, 2005.

By participating in separate collection of products and batteries, you will help to assure the proper disposal of products and batteries and thus help to prevent potential negative consequences for the environment and human health.

For more detailed information about the collection and recycling programmes available in your country, please contact your local city office or the shop where you purchased the product.

Disposal of batteries and/or accumulators

The crossed out wheeled dust bin symbol indicates that batteries and/or accumulators must be collected and disposed of separately from household waste.



If the battery or accumulator contains more than the specified values of lead (Pb), mercury (Hg), and/or cadmium (Cd) defined in the European Battery Directive, then the chemical symbols for lead (Pb), mercury (Hg) and/or cadmium (Cd) will appear below the crossed out wheeled dust bin symbol.

By participating in separate collection of batteries, you will help to assure the proper disposal of products and batteries and thus help to prevent potential negative consequences for the environment and human health. For more detailed information about the collection and recycling programmes available in your country, please contact your local city office or the shop where you purchased the product.

REACH information

The European Union (EU) chemical regulation, REACH (Registration, Evaluation, Authorisation and Restriction of Chemicals), entered into force on 1 June 2007.

Toshiba will meet all REACH requirements and is committed to provide our customers with information about the presence in our articles of substances included on the candidate list according to REACH regulation.

Please consult the following website www.toshiba-tv.com for information about the presence in our articles of substances included on the candidate list according to REACH in a concentration above 0.1 % weight by weight.

EU Conformity Statement



This product is carrying the CE-Mark in accordance with the related European Directives.

Responsible for CE-Marking is Vestel UK, Langley, Berkshire, SL3 6EZ.

This product is labeled with the CE Mark in accordance with the related European Directives, notably RoHS Directive 2011/65/EU. Furthermore the product complies with the Ecodesign Directive 2005/32/EC (EuP) and 2009/125/EC (ErP) and its related implementing measures.

This equipment corresponds to requirements of the Technical Regulation on limitation of usage of certain dangerous substances in electrical and electronic equipment.

Find out all you need to know about the latest, trend-setting TV technology on our website.

www.toshiba-tv.com

You can download the full manual, watch support videos, learn latest FAQs, stick your head into the forum, or register your TV in the support section.

Hereby, VESTEL Elektronik Sanayi ve Ticaret A.Ş., declares that the radio equipment type TV is in compliance with Directive 2014/53/EU. The full text of the EU declaration of conformity is available at the following internet address: doc.vosshub.com

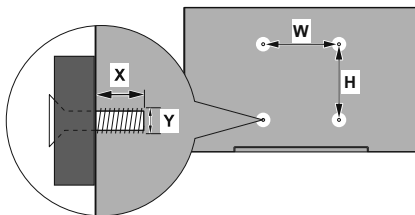

VESA WALL MOUNT MEASUREMENTS

Hole Pattern Sizes (mm)	W	H
	200	200
Screw Sizes		
Length (X)	min. (mm)	10
	max. (mm)	13
Thread (Y)	M6	

TOSHIBA



50577567